



4'x8' Storage Shed Plan

Disclaimer

The information provided here will show you how to build a shed. However, howtoplans.org does not claim that the recommended techniques are the only way to accomplish this task. It will be the responsibility of each customer to ensure the application of the correct construction methods and the use of the proper materials.

In addition to the selection of the materials, the customer will be responsible for such construction tasks as caulking, flashing, gluing, insulating, and nailing, and for adequate workmanship in the areas of installation, roofing and weatherproofing, as well as for any other skills that are beyond the control of the designer. The materials mentioned in the plans do not represent an endorsement or recommendation of any particular product.

The Responsibility of Users

Despite our commitment to presenting accurate information, howtoplans.org is not liable for any errors or omissions appearing in the plans. Furthermore, howtoplans.org will not be liable for any consequential, special, incidental or indirect damages resulting from the use of this information. Our freedom from liability also extends to such issues as the loss of anticipated profits or business opportunities, and economic losses stemming from the use of howtoplans.org, regardless of whether there has been notification of such damage.

Liability

Those who utilize the methods described on howtoplans.org will be responsible for their own actions. We are not liable for any injuries or property damage that may arise from the use of the information appearing on this website. If you decide to use these plans, you should use only quality materials and should always follow good safety practices. In the event that you are unable to complete the project on your own, you should contact a certified contractor to ensure that construction is completed in accordance with the highest standards.

Permissions

It is important to understand that planning and permission issues are dependent upon local requirements. Users of these plans are responsible for complying with the appropriate statutes and regulations, and for the proper implementation of the plans or other construction information provided by howtoplans.org. The city or county office in your area should be able to provide you with the relevant information.

Copyright

The text and illustrations that appear here are the exclusive property of howtoplans.org and are protected by federal copyright laws. The one-time use of the plans is limited to anyone who purchases them. The duplication, publication, sale or distribution of any portion of these plans without prior written consent from the original designer will be subject to the appropriate penalties for copyright infringement.

4'x8' Lean-to Shed Material List

Site Preparation

- Concrete
- Bricks

Bottom Frame

- Pressure-Treated Lumber
- Plywood

Front/Back/Side Wall Frames

- Pressure-Treated Lumber

Shed's Roof

- Pressure-Treated Lumber
- Pressure-Treated Board
- Plywood
- Building paper
- Asphalt shingles
- Metal drip edge

Shed's Front Window

- Pressure-Treated Lumber
- Window beading
- Glass

Shed's Door

- Pressure-Treated Lumber
- Plywood

Front/Back/Side Wall Exterior Siding

- Pressure-Treated Lumber
- Wood siding boards

Top Frame

- Pressure-Treated Lumber

Fasteners & Hardware

- Door hinges
- Door pulls
- Surface bolt
- Corner braces
- Wood square louver gable vent
- Galvanized nails
- Wood screws

STEP 1

Foundation Preparation

1.1 Clear the area where you want to build the shed and layout for the foundation. Use the below illustration as a guide.

1.2 For the foundation, dig the trenches at least 1 foot wide and 1 foot deep.

1.3 Fill the trenches to ground level with concrete and let cure, or harden. Since curing times vary between brands, read the packaging for recommended curing times.

1.4 Once the concrete has cured, use standard-sized bricks and lay them across the foundation. You will need roughly 65 bricks for this step.

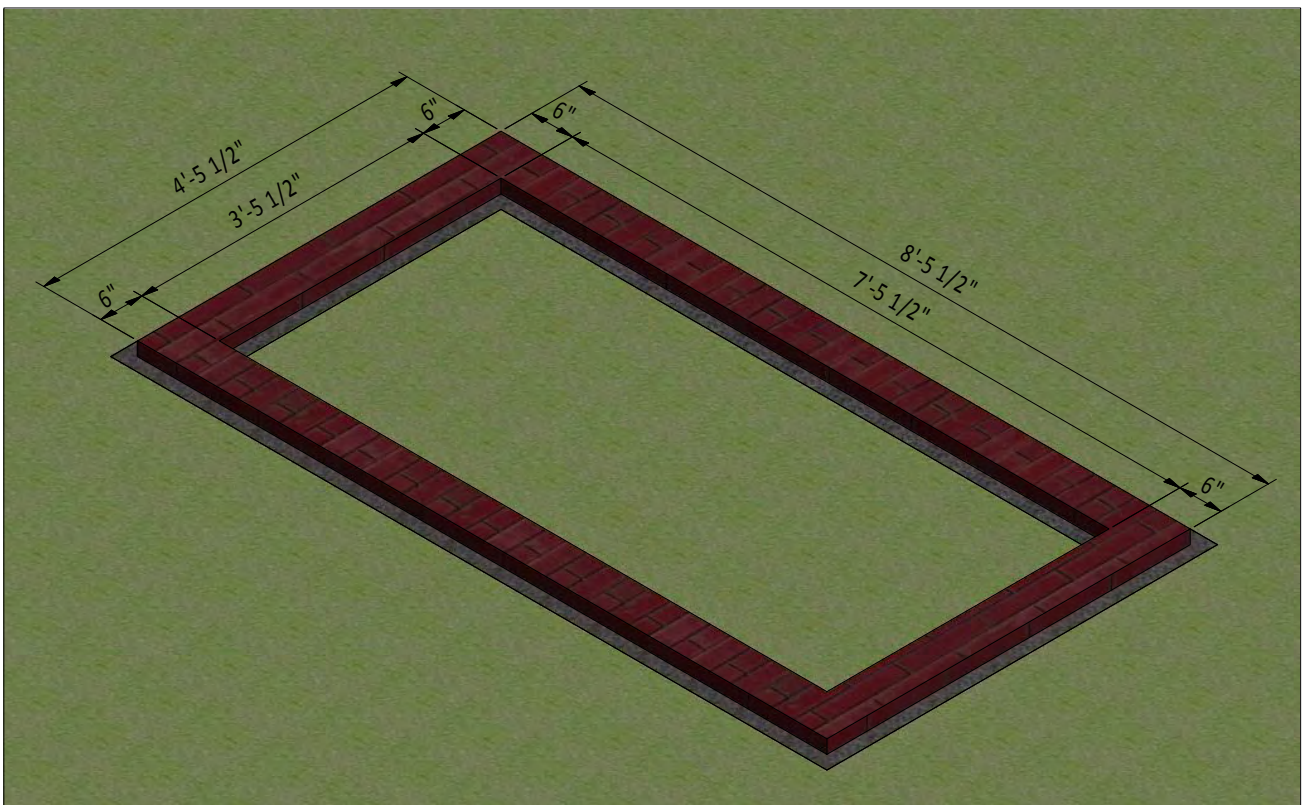

STEP 2

Framing the Floor

2.1 Assemble the frame using 1 1/2" x 7 1/4" pressure-treated lumber. You will need two boards cut to 8' that will be the rim joist and two boards cut to 3'-9" that will be the joist.

2.2 Secure the beams with 8x5" wood screws.

2.3 Using a speed square or carpenter's square, check the corners to make sure they are 90°.

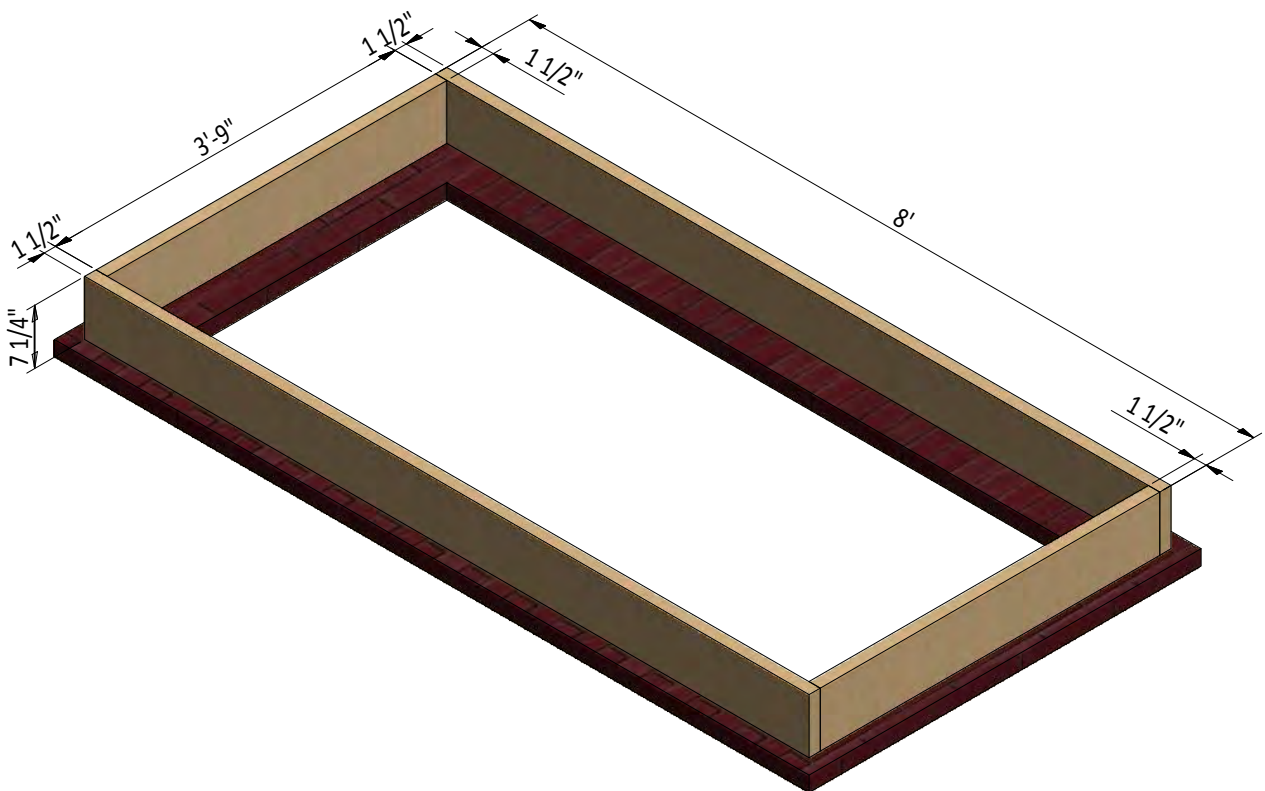

STEP 4

Assemble Back Wall Frame

4.1 Using 1 1/2" x 3 1/2" and 3 1/2" x 3 1/2" pressure-treated lumber, construct back wall frame using the drawing below as a reference. You will need seven boards cut to 8'-3" that will be the studs and two boards cut to 8' that will be the top and bottom plates.

4.2 Connect the beams with 2x3" wood screws.

4.3 Using a speed square or carpenter's square, check the corners to make sure they are 90°.

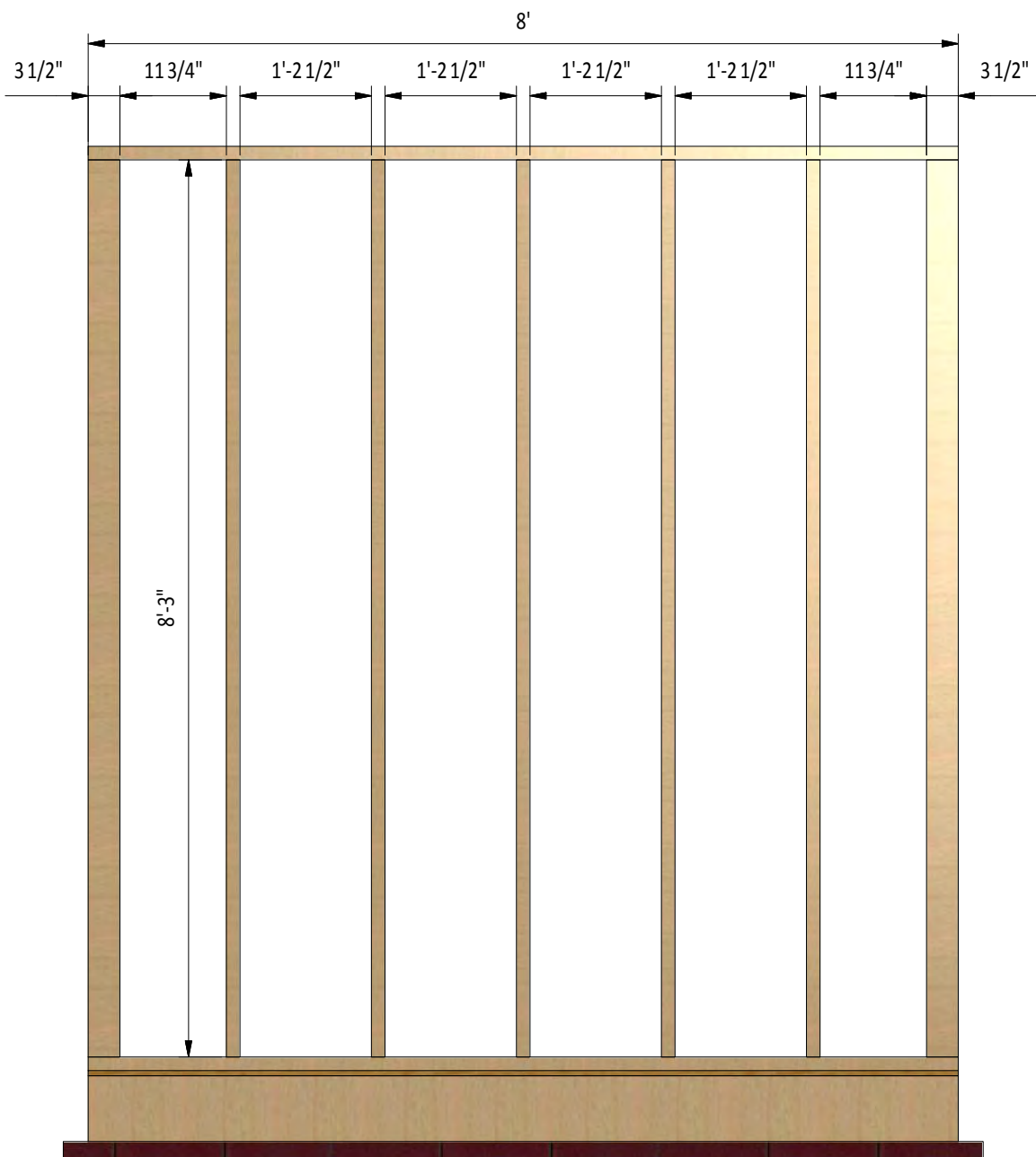

STEP 5

Assemble Right and Left Wall Frames

5.1 Using 1 1/2" x 3 1/2" pressure-treated lumber, construct side wall frame using the drawing below as a reference. You will need four boards cut to 7'-3" that will be the studs and two boards cut to 3'-5" that will be the top and bottom plates.

5.2 Connect the beams with 2x3" wood screws.

5.3 Using a speed square or carpenter's square, check the corners to make sure they are 90°.

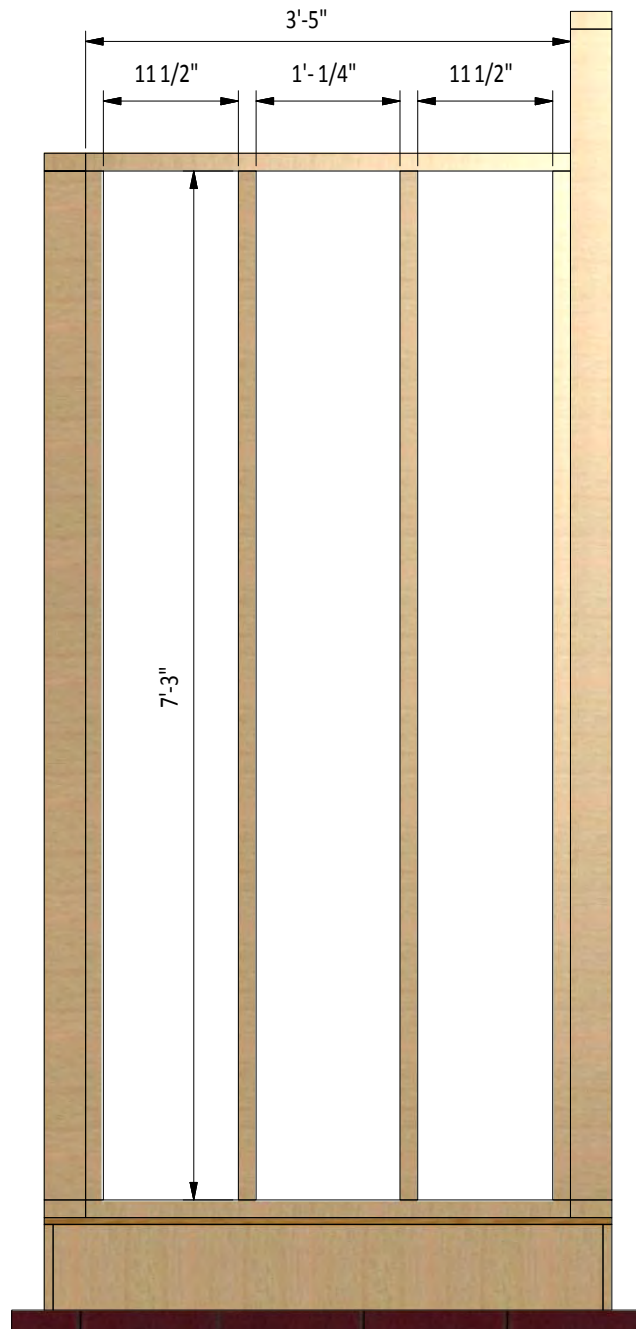

STEP 6

Assemble The Roof Frame

6.1 Using 1 1/2 " x 5 1/2 " pressure-treated lumber, cut seven rafters 5'-6 1/4" long according to the dimensions in drawing below. Cut the recesses in each beam for splicing connection with wall frames.

6.2 Connect the beams with a top frame with the help of 3" wood screws.

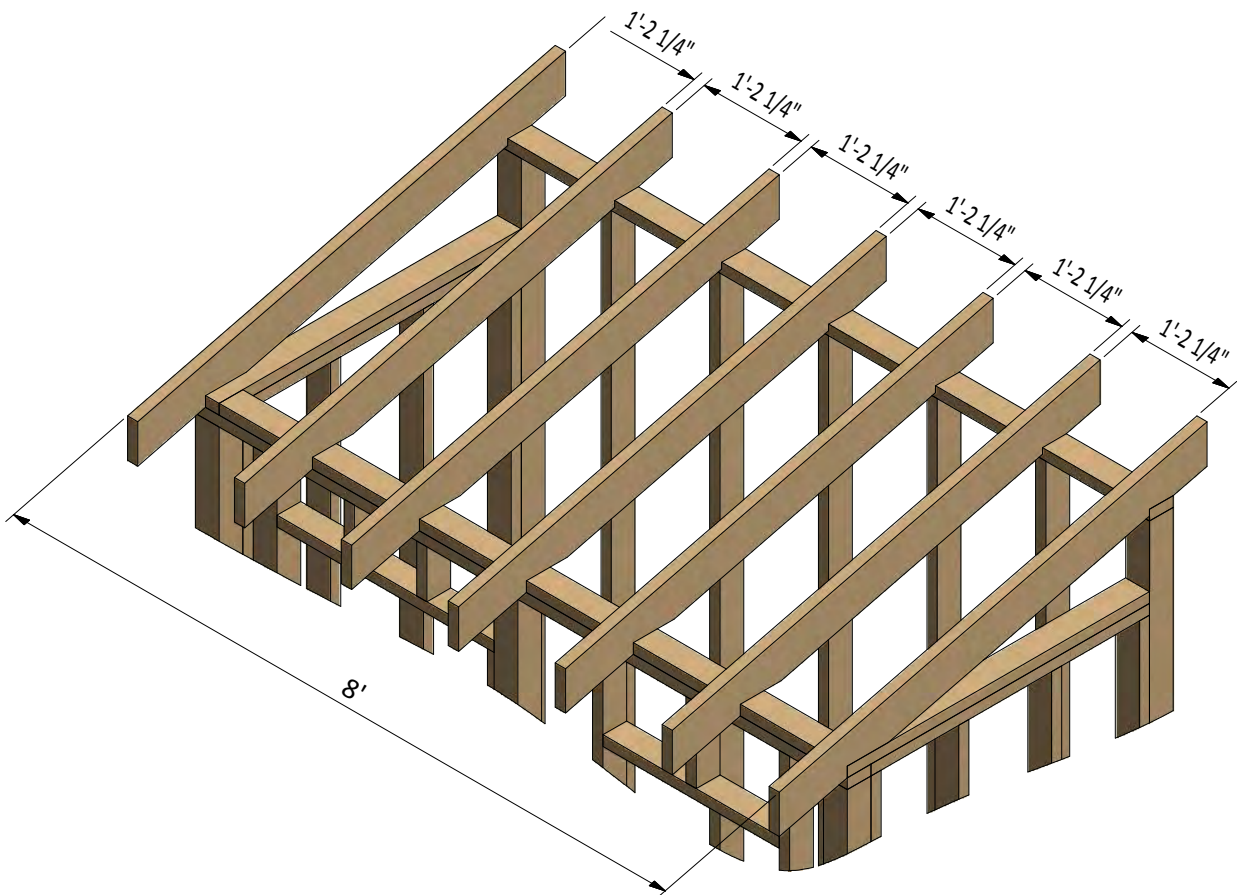

STEP 7

Window Installation for the Front Wall

7.1 Using 1 1/2 " x 2 1/2 " pressure-treated lumber, assemble the frame for the window as shown in the drawing below. You will need two boards cut to 1'-11" that will be the vertical girts and two boards cut to 2'-2" that will be the horizontal girts. Connect them with 2x3" wood screws. Mill a recess for the glass.

7.2 Prepare and install 1/8" glass into inner frame groove and fasten it by window beading from four sides. You will need one sheet 1'-11 1/2" x 1'-11 1/2" of the glass. Use 1/2" galvanized nails.

7.3 Insert window into front wall opening and connect them with 8x3" wood screws to the wall beams.

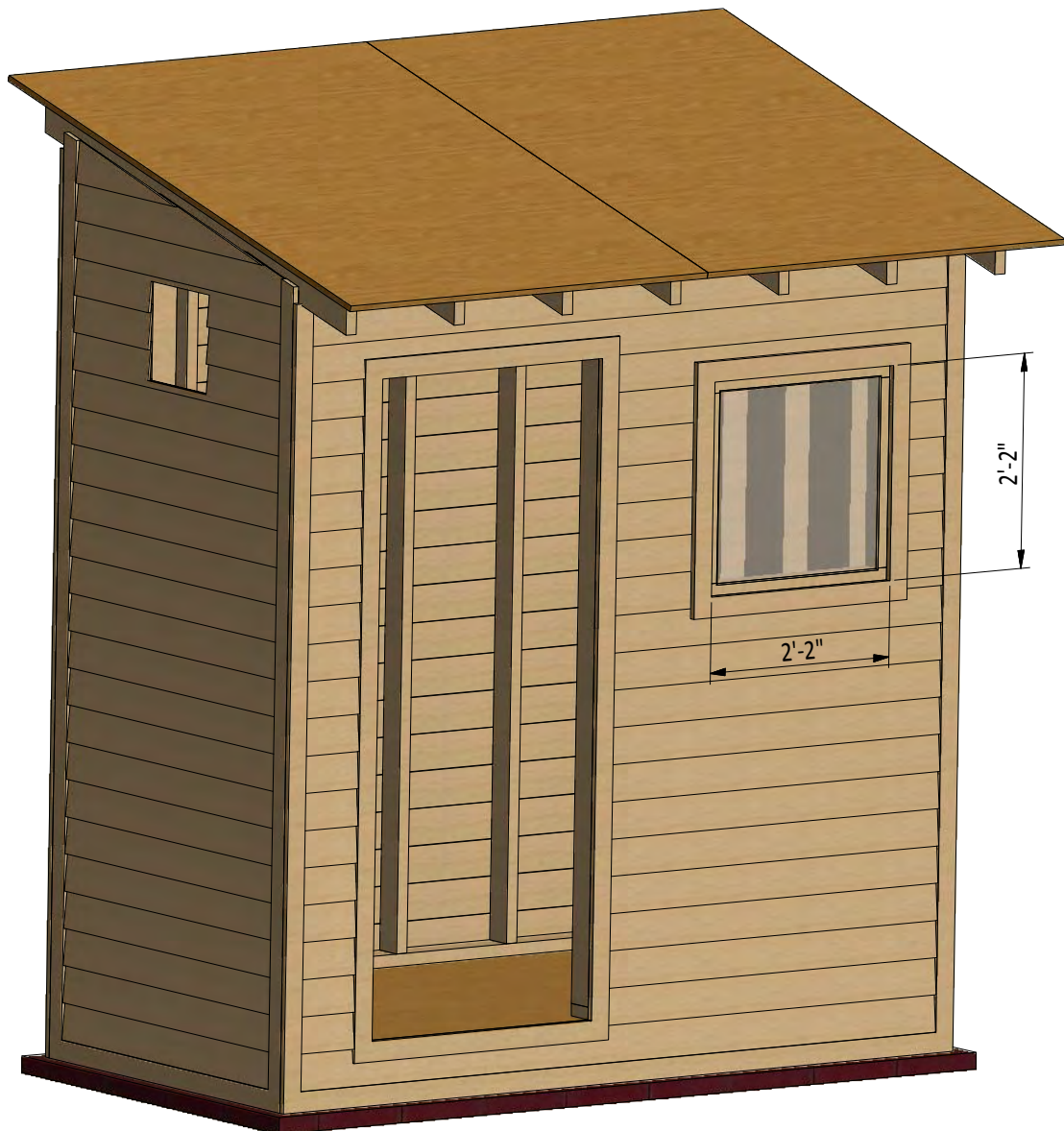

STEP 8

Assemble and Install Shed's Door

8.1 Build the door frame for the coop using 1 1/2 " x 3 1/2 " pressure-treated lumber and secure with 5" wood screws. You will need two boards cut to 6'-7 1/2" that will be the vertical girts, three boards cut to 2'-1 1/2" that will be the horizontal girts and two boards cut to 3'-6 1/4" that will be a cross braces.

8.2 Use 3/4" x 2 1/2 " pressure-treated lumber for the door trims and fasten with 2" wood screws. You will need two boards cut to 6'-2 1/2" and two boards cut to 2'-7 1/2".

8.3 Using 1/4 " x 3/4 " pressure-treated lumber, cut and install a starter course 2'-2 1/2" long.

8.4 For the exterior siding on the door, use 1/2 " x 6" wood siding boards and the illustration below as a reference.

8.5 Assemble siding shields with 2" galvanized nails.

8.6 Install three 3" door hinges using 6x1" wood screws. Finish the doors installation by attaching 4" surface bolt and 6" door pull.



STEP 9

Roof Sheathing Installation

- 9.1 You will need 55 Sq Ft of asphalt shingle roofing.
- 9.2 Add the metal drip edge to the fascias.
- 9.3 Cover the plywood with building paper.
- 9.4 Install asphalt shingle roofing using an industrial stapler.

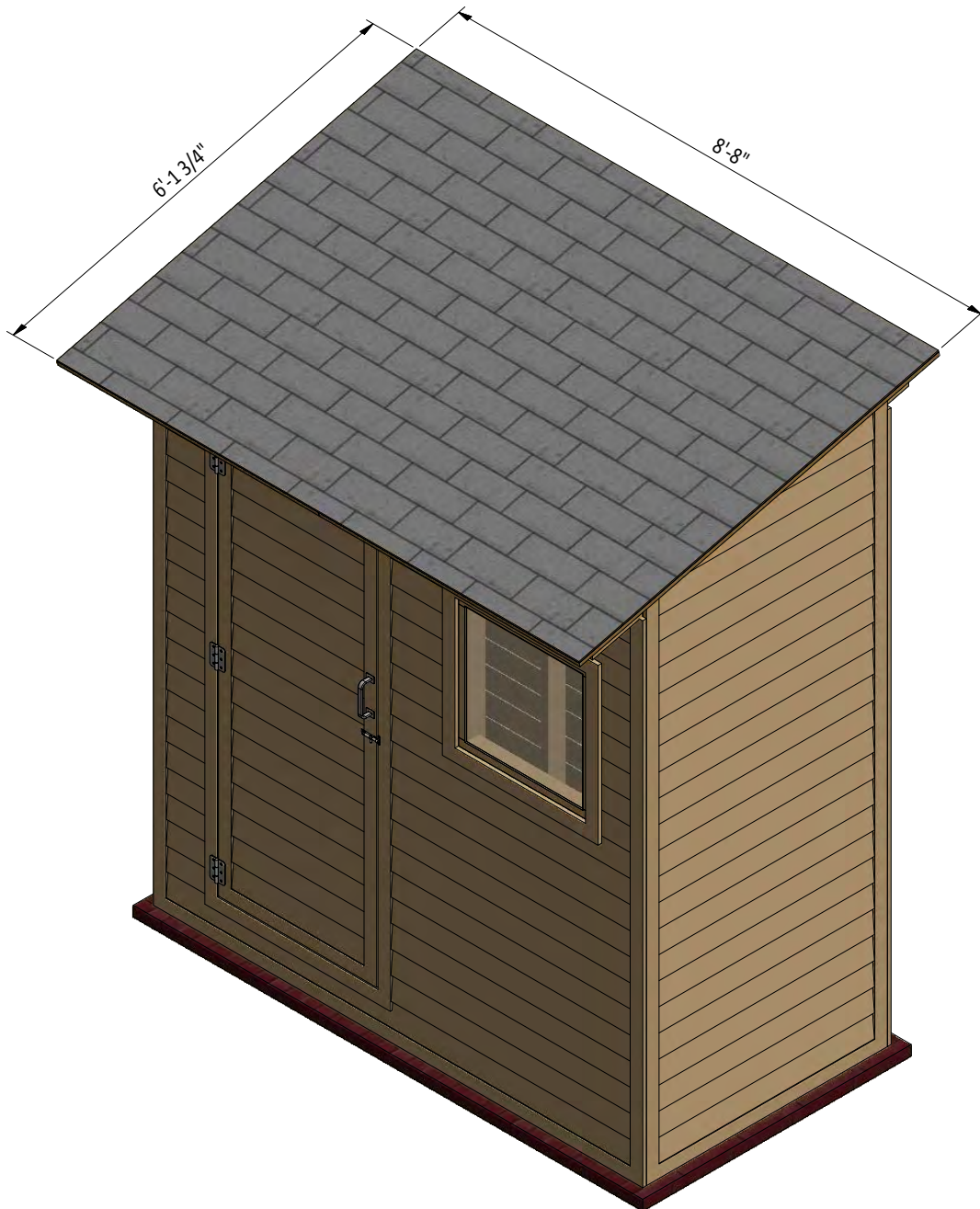

STEP 10

Shed Decoration

Now that your coop is all done, you are ready to decorate it any way you want using your favourite paint, stain, or preservative.





For more great **HOW-TO** plans please visit: www.howtoplans.org

Copyright

The text and illustrations that appear here are the exclusive property of howtoplans.org and are protected by federal copyright laws. The duplication, sale or distribution of any portion of these plans without prior written consent from the original designer will be subject to the appropriate penalties for copyright infringement. Sharing this plan on the web is only permitted with an indicated original source: <https://www.howtoplans.org>